

Protect
your people
and your
productivity.





EVERYONE'S SAFETY HANGS IN THE BALANCE.

The facts are alarming. According to data compiled from the Bureau of Labor Statistics, each year, hundreds of workers are killed and thousands are seriously injured by preventable workplace falls. In addition to the tragic human toll, these accidents cost businesses billions each year in medical costs, fines and lawsuits. Now, regulatory agencies are tightening their requirements for fall protection even more, and increasing penalties and fines for noncompliance.

Are you putting your company and employees at risk?

Engineered solutions that are A Class Above.

Gorbel is dedicated to improving safety and productivity in every industrial environment. Our engineered systems can be tailored to your specific industrial application—whether it's indoors or out, stationary or covers multiple areas. Today, Gorbel uses proven concepts to develop unique solutions for protecting workers at heights. By matching the right system to your exact job requirements, we offer superior safety while keeping productivity at essential levels. Whether the job requires protection throughout the day as part of production, cleaning, or painting activities, or just for sporadic activities, Gorbel offers a comprehensive line of fall arrest solutions that you and your workers will embrace.



ELIMINATE THE GUESSWORK WITH TETHER TRACK.

If your employees work at heights of FOUR FEET or more in general industry, you need fall protection. But not all fall protection is created equal, you need a system that meets your specific application requirements. Gorbel Tether Track fall arrest systems can do that.

FALL ARREST DESIGNED WITH YOU IN MIND.

At Gorbel, we understand that you face unique challenges when protecting your workers at heights. To address these challenges, Tether Track is available in a variety of engineered configurations suitable for nearly every indoor and outdoor application. All rigid rail systems described here are designed for components that are rated for the industry standard 900 pounds maximum arresting force (MAF). Since each system has unique characteristics, problem-solving is addressed at various levels, starting with onsite consultations with a knowledgeable dealer or representative. From there, our team of customer service representatives and fall protection product specialists are on hand to assist in providing the exact system to meet your needs.

Gorbel's engineering team provides custom solutions for a wide range of activities. Dedicated, qualified engineers can provide various options to address applications where "off-the-shelf" devices may be insufficient. Individual welders are certified in accordance with Structural Welding Code AWS D1.1, to ensure that the product you receive is of a consistent, premium quality.

COSTS OF A FALL

When examining all of the potential costs associated with a fall, Tether Track represents an effective "insurance policy," offering tremendous value. The direct costs of a fall can be seen in escalating medical insurance premiums and workers' compensation costs. An OSHA investigation could occur, resulting in fines. But, there are indirect costs, such as lost-time charges and the time spent to hire and/or train a replacement worker. Some costs are difficult to measure, but there is no guarantee that an employee who suffers a fall will ever be as productive as before, when they return to work. It is only human nature to worry about a fall after experiencing such an event, rather than focusing on the job at hand, if they return to work at all.

PEACE OF MIND

Utilizing Tether Track as part of a complete fall arrest system provides an optimal solution to protect your workers. With so many companies touting strict policies regarding safety, Tether Track is a perfect fit in a safety-conscious culture. Providing maximum protection for workers at heights with quality equipment designed specifically for the task is reassuring to all levels of the organization.

OSHA regulations 1926 and 1910 mandate fall protection for employees working at or above these heights.

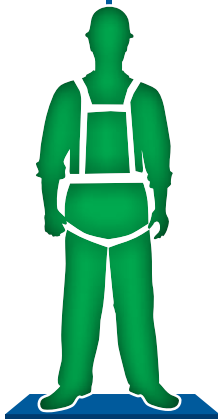

8'

Longshoring
Operations

6'

Construction
Industry

5'

Shipyards

4'

General
Industry



Any height when
working over
dangerous
equipment and
machinery

ENGINEERED SYSTEMS

Tether Track Engineered Systems utilize an innovative enclosed track system to protect your workers from injury due to falls while maximizing their productivity. Available in a variety of track styles and specifications, all of our engineered systems meet or exceed ANSI and OSHA fall protection standards.

MAXIMUM PROTECTION, UNMATCHED MOBILITY

Gorbel's engineered Tether Track Rigid Rail Fall Arrest Systems are a reliable, cost-effective way to reduce the risk of injury in elevated work environments. Unlike some systems, these systems enable workers to effortlessly pass one another without disconnecting from the system—minimizing the risk of a fall during the reattachment process.

INNOVATIVE RIGID ANCHOR TECHNOLOGY

The building block for our rigid rail anchor system is our enclosed track design, which is engineered for easy movement. The cold-rolled steel track keeps dirt and dust from settling on the rolling surface, allowing for smoother, more consistent ease of movement than an I-beam with no need for cleaning or maintenance of the track.

The track also features a running flange with a 2-degree taper to keep the trolley centered. That allows the trolley and attached lanyard to easily follow the worker, rather than forcing them to pull free a trolley that has become stuck.

Our rigid rail anchor systems are designed by qualified engineers to meet or exceed the OSHA 1926 Subpart M Construction standard, the 1910.66 App. C General Industry Standard, and ANSI Z359 Fall Protection Code using a maximum off-vertical loading of 30 degrees. This strict design criteria means that our track supports the full impact of falls vertically and also at a 30-degree angle. That's important for applications where the risk is to fall off the side of an object rather than straight down.



2-degree taper keeps
the trolley centered



THE BENEFITS OF TETHER TRACK RIGID RAIL OVER WIRE SYSTEMS:

STOPS FALLS FASTER: Tether Track requires less fall clearance than wire rope systems, making it ideal for low-headroom applications.

LOWER MATERIAL AND INSTALLATION COSTS: Tether Track covers greater distances between supports, thus requiring less material to cover the same overall area.

SAFER FOR MULTIPLE WORKERS: Unlike wire rope systems, multiple workers are not impacted by each other's movements.

REQUIRES NO STRUCTURAL MODIFICATIONS: Tether Track's rigid anchor point eliminates the need to modify building structures.

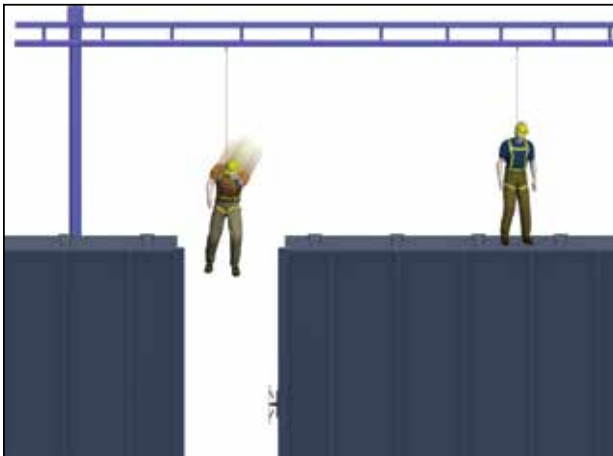

Tether Track Rigid Rail Fall Arrest Systems provide shorter free-fall distances, reduced risk of secondary fall injuries, such as swinging into obstacles, and no negative impact on a second worker in the event of a fall.

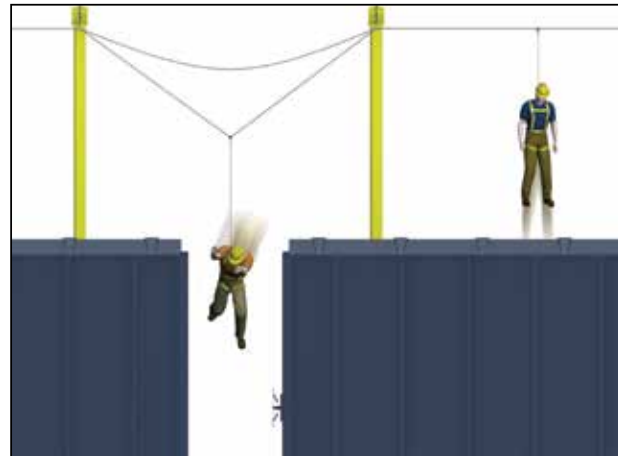

Wire rope systems can create hazardous situations due to the dynamic sag of the wire after a fall.

TETHER TRACK® ENGINEERED SYSTEMS



Monorail Systems

FREE STANDING

Engineered for areas that require long spans and an independent structure for support, this system provides a single path of fall protection in a permanent manner. Used widely in areas where floor space is readily available, Free Standing Monorail Systems are ideal for the transportation and agricultural markets. Numerous configurations are available, including cantilever designs offering economical options and long span capabilities. They are extensively used for outdoor applications and can be treated with special finishes to withstand the elements.

Free standing cantilevered monorails are available in heights up to 26 feet to effectively protect workers maintaining, inspecting, or loading/unloading railcars, tankers, or flatbed trucks.



CEILING MOUNTED

When floor space is at a premium, ceiling mounted monorails can provide unparalleled fall protection while maintaining an open floor plan for material handling, production, or related activities. Ceiling mounted monorails use existing support steel for overall anchorage strength, and are ideal for production facilities and warehouses with tall ceilings since column support is not needed. Even if the facility has standard ceiling heights, the compact, low-profile design of ceiling mounted monorails provides full protection without head-room concerns.



AUTO PARTS DISTRIBUTION

Safety and Productivity at Every Turn

A major auto parts distributor was concerned about the safety of employees who were required to climb out onto their extensive conveyor system to perform maintenance and repairs. In exploring their fall protection options, they were concerned that their curved conveyors—in particular, a floor-to-ceiling spiral conveyor—would make it impossible to provide adequate fall arrest protection.

The solution was to install four plain-track, straight monorail systems in one building. Three of the systems were 282' long, and the other was 102' long, and covered the straight conveyors in that building. In the second building, a 340' straight monorail that feeds into multiple curved monorail sections was installed to cover the straight conveyor lines. Now, when workers perform maintenance on the conveyors, they simply attach the lanyard to their harness and have fall protection every step of the way.

A fall arrest solution that conquers a distributor's curved conveyor concerns.

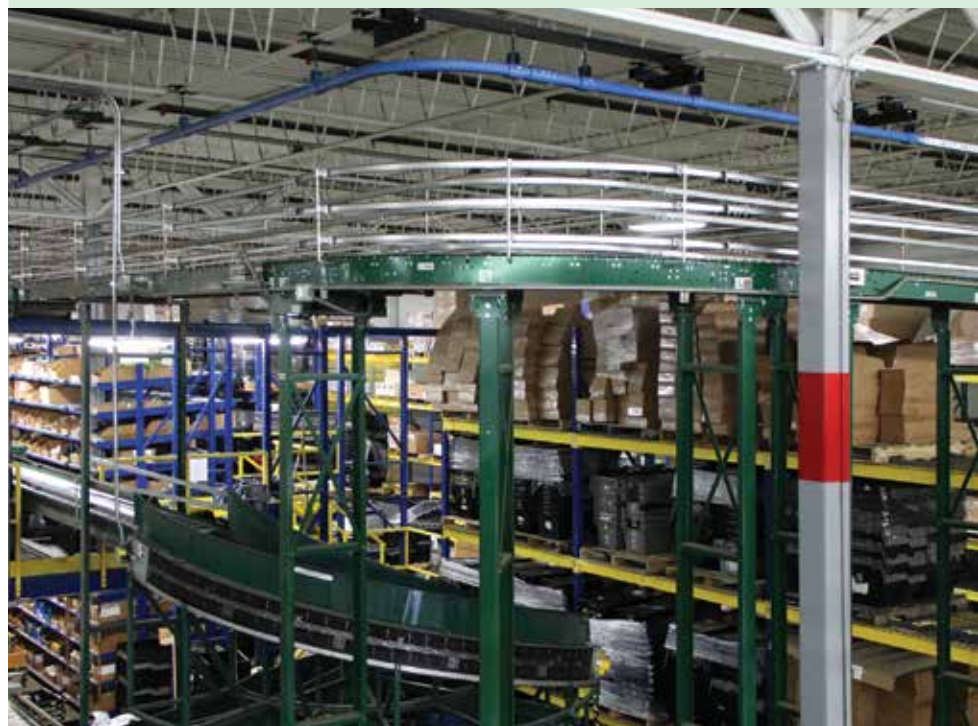

TETHER TRACK® ENGINEERED SYSTEMS

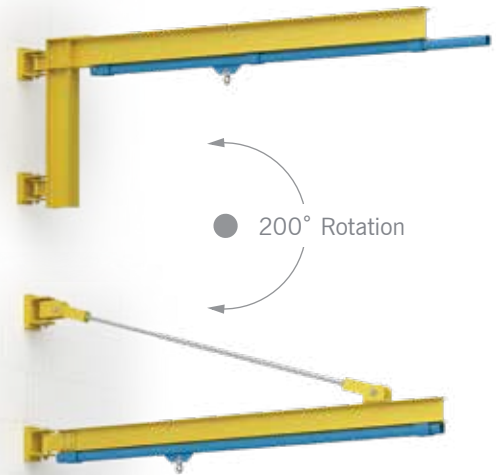

Swing Arm Systems

When space is an issue or ceilings are inaccessible, swing arm systems can provide flexible solutions in industries ranging from food distillation to coal processing. The Tether Track Swing Arm Fall Arrest Systems provide circular or semicircular fall protection within a limited footprint. Used extensively in areas where both overhead cranes and fall protection systems share the same space, Swing Arm Systems may be mounted to an existing wall column or to the floor in a free standing configuration. Since Swing Arm Systems may be easily moved out of the way when not in use, they are ideal for applications where infrequent fall protection is necessary.

- Available in Wall Cantilever or Wall Bracket Configurations based on headroom constraints
- Turnkey drive packages available
- Standard spans 8' to 30'; custom spans are also available
- Friction brake is included for multiple-worker systems; also an option for other systems



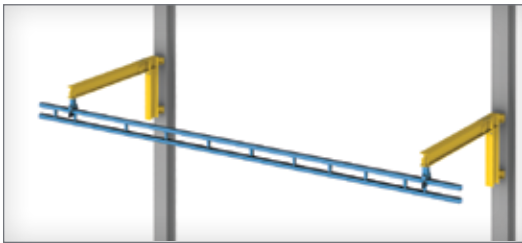

Fully-deployed system

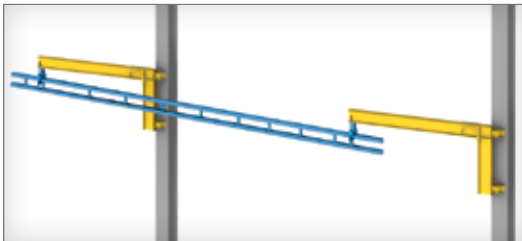

Folds away when not in use

Fold Away Systems

Gorbel's Fold Away Systems provide safety when you need it, and space when the system is not in use. Similar to the Swing Arm Systems, Tether Track Fold Away Systems supply convenient fall arrest when extended without sacrificing productivity.

Ideal for areas such as railroad maintenance facilities or where large food processors must be regularly maintained, these systems may be easily moved from the work environment when fall protection is not essential. By deploying only when needed, Fold Away Systems allow complete access to overhead cranes in order to keep production at high levels.

- Unlimited lengths with up to 50' between supports
- Motorized rotation available
- Trussed track to accommodate single or multiple workers
- Available in free standing or wall/column mounted designs

TETHER TRACK® ENGINEERED SYSTEMS



Bridge Systems

Like monorail systems, bridge systems are available in either free standing or ceiling mounted configurations.

CEILING MOUNTED SYSTEMS use the structure for support, as the rail is mounted either perpendicular or parallel to the ceiling beams. Should overhead obstacles be present, drop rod hangers with sway bracing can be supplied so that the system avoids these obstructions.

FREE STANDING SYSTEMS may be preferred whenever floor space is readily available to install column supports, when changes in work practices are anticipated, and when a building structure isn't available. The flexibility of free standing systems allows them to be easily modified and moved should processes or fall protection needs change.

Multiple bridges can be supplied for both ceiling mounted and free standing systems, thus allowing multiple workers to utilize the system simultaneously.

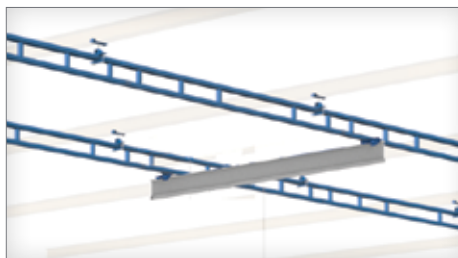

Ceiling Mounted

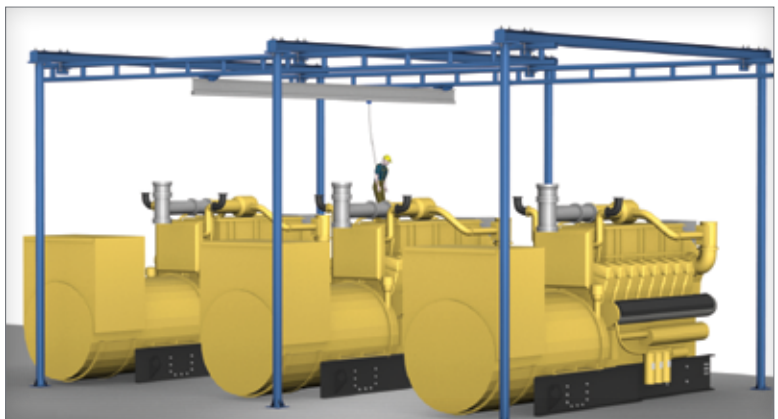

Free Standing



Portable Gantry Systems

The Tether Track portable fall arrest gantry is ideal for applications where a permanent solution is not possible. It allows for single or multiple users to complete their required tasks, and can then be moved out of the way when not needed. The square tubing uprights, knee braces, and channel base allow for stable movement, while the Tether Track trolley rolls smoothly on an enclosed track flush mounted beneath the beam.

- Available at fixed heights up to 20 foot hook height, and spans up to 20 feet
- Adjustable heights available as an option
- Multiple areas can be serviced with a single, portable unit
- Different caster options available dependent on the environment
- Casters include cam breaks and swivel locks to keep gantry from moving



BUS MAINTENANCE

Tether Track Brings Peace of Mind to Transportation Authority

Recently, a transportation authority began replacing old buses with more fuel-efficient hybrid vehicles to decrease fuel costs and emissions. When these new buses need maintenance, workers must climb to the bus roofs to cut power from the electric battery packs. The solution was installing four identical ceiling mounted Gorbel Tether Track anchor systems with Miller self-retracting lanyards with 20 feet of line. The Tether Track style chosen featured a 39-foot-long dual-trussed monorail, which fully covers the length of the buses and allows for multiple workers to be on the roof of the bus and safely pass one another.

TETHER TRACK® ENGINEERED SYSTEMS

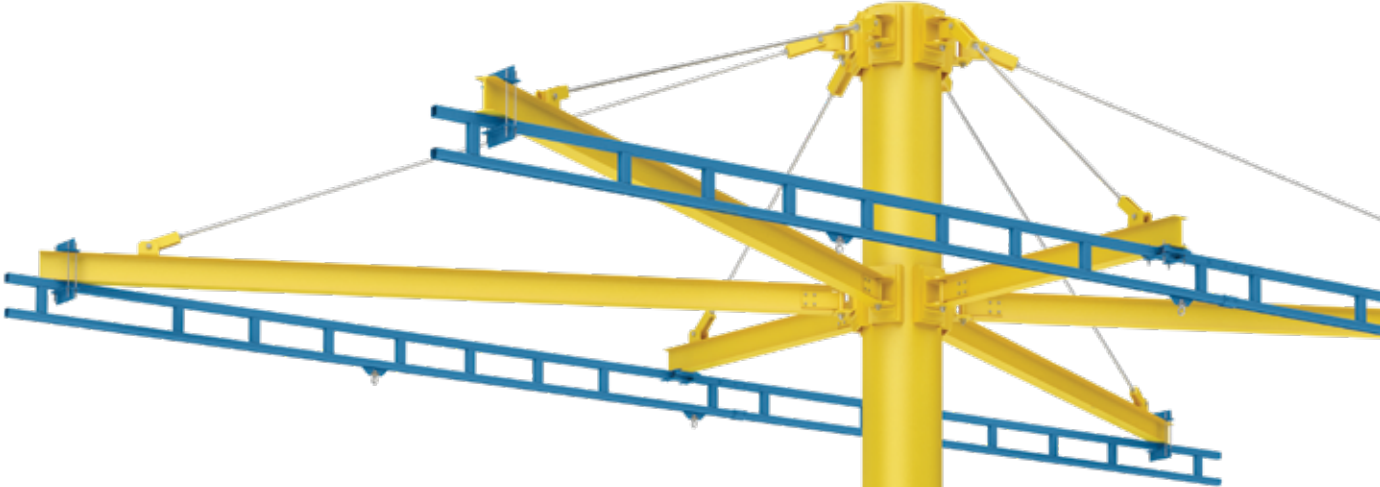

2 Bay System: Our single-post system requires a single foundation, saving you money and space.

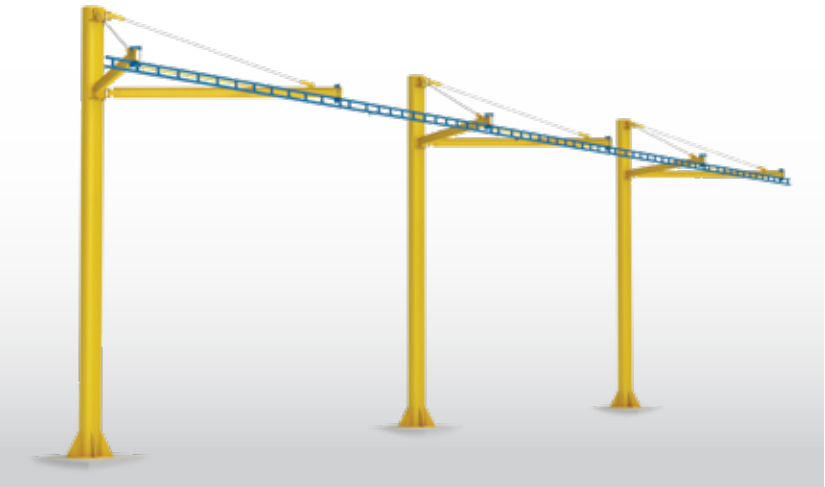

The linked single-pole configuration allows spanning greater distances between supports.



Single Pole Systems

When numerous obstacles exist in the work space and standard multiple-column systems are not practical, single pole systems provide a convenient alternative. Used regularly in tank car servicing or heavy-duty truck securing and tarping areas, single pole systems require only a single foundation. Standard span lengths from 10' to 53' mean the system can be designed to meet the requirements of most loading/unloading and maintenance facilities.



SYSTEM COMPONENTS & CUSTOMIZATION

All the components you need to create your own system.

In addition to our standard systems, Tether Track® can be customized to meet your specific needs. Whether your requirements are driven by the needs of your workforce, your workspace, or environmental conditions, our certified engineers and welders will create a Tether Track system that's right for you.



For more information about customizing the right solution for your specific need, call 1-844-268-7055.



Tracks

PLAIN TRACK

Plain enclosed steel track provides smooth motion with the benefit of offering the most headroom of any track style.

Track Series	MAXIMUM SUPPORT DISTANCES ¹		MAXIMUM CANTILEVER ²	
	1 Worker	2 Workers	1 Worker	2 Workers
F500	12 feet	7 feet	2.5 feet	1.5 feet
F1000	18 feet	12 feet	4 feet	2.5 feet

TRUSSED TRACK

Single trussed track allows for the longest possible spans between supports, reducing hardware and installation costs.

Track Series	MAXIMUM SUPPORT DISTANCES ¹		MAXIMUM CANTILEVER ²	
	1 Worker	2 Workers	1 Worker	2 Workers
F500S	20 feet	16 feet	4.5 feet	3.5 feet
F500SL	25 feet	18 feet	5.5 feet	4.5 feet
F500SLX	30 feet	22 feet	6.5 feet	5.5 feet
F500Z	50 feet	40 feet	5.5 feet	5.5 feet

DUAL TRUSSED TRACK

The dual track enables one worker to pass by another on a monorail system without unsafely disconnecting.

Track Series	MAXIMUM SUPPORT DISTANCES ¹	MAXIMUM CANTILEVER ²
F500SLD	35 feet	5.5 feet
F500ZD	50 feet	5.5 feet

¹ For longer support distances or custom applications, contact Gorbel Inside Sales.

² Cantilever is the overhang distance from the system's last support.

Intended for indoor use. For outdoor applications, contact Gorbel Inside Sales.



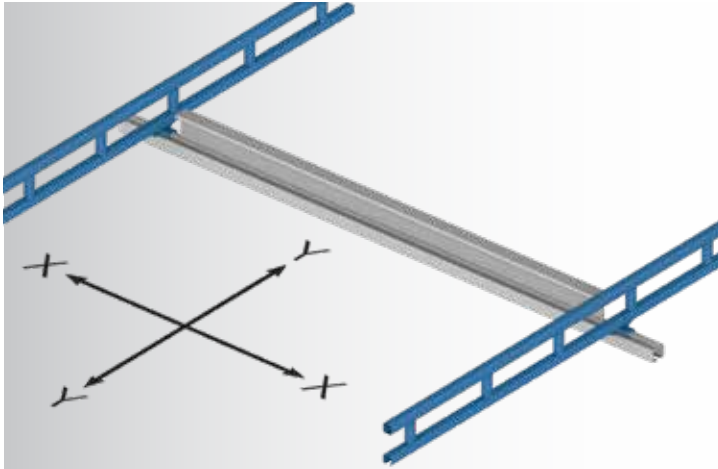

Aluminum Bridges

The bridge system allows for two axes of motion. This gives the worker complete mobility along the x and y axes, while keeping the fall protection anchor point directly over the worker's head, reducing the risk of swing fall injuries. Multiple bridges are the best solution for supporting multiple workers.

- Up to 45% lighter than steel bridges
 - Allows bridge to follow workers' movement at all times, limiting fall distance
- Suited for different types of environments
- 18' maximum standard bridge length
- Longer bridges available upon request
- Easier for the worker to move around

Sway Bracing

- Required on ceiling mounted systems, offered as option in other configurations

Tractor Drives

- Available on bridge systems
- Ideal for more than one user per bridge

Hangers and Supports



Standard assembly
(upper/lower hanger
bracket)



Flush mount

Also:

- Plain support brackets
- Plain and trussed track:
20" standard rod drop



Drive Package

- Consists of a reducer, clutch, motor, junction box, electrical enclosure, panel, and conduit
- Four different drive packages available, based on span, bracket center distance, and fitting size

Friction Brake

- Optional friction brake stops the rotation of the swing arm or fold away
- Infinitely variable disc brake can be locked out at any degree interval
- Allows for multiple users to work safely on the same track

The Drive Package and Friction Brake apply ONLY to Swing Arms and Fold Away Systems.

Recover Trolley

The Recover Trolley locks in place when a fall occurs to increase the possibility of the worker regaining composure and reaching the work surface for an efficient recovery from a fall.

- Low rolling resistance
- May reduce suspension trauma
- May provide additional rescue options when self-recovery does not occur



Tether Trolleys™

- Provide fluid movement and stability
- Features innovative DURACOMP 4® wheels
- Swivel eye allows for free movement beneath trolley
- 3-axle design prevents binding inside the track when side loaded

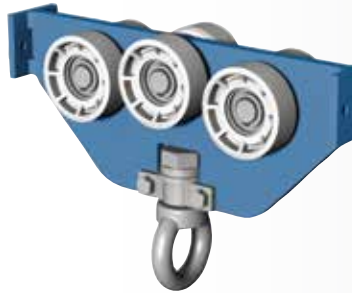

MONORAIL TROLLEY

- Specifically designed for fall arrest applications
- Smooth running
- DURACOMP 4® wheels
- 2-degree taper on all wheels
- 3-wheeled design for 30-degree offset loads
- Swivel prevents twisting of the lanyard

CURVED MONORAIL TROLLEY

- More compact, 3-wheel design with shorter wheelhouse
- Short wheel base allows trolley to navigate smoothly through curves without binding

BRIDGE

- The bridge always follows the worker and is directly above them

Wheels

- Made of DURACOMP 4® material that delivers unmatched durability and consistent long-term performance
- Reduced wear
- Quieter
- Variable temperature operation (from 5 to 250 degrees F)
- Sealed lubricated bearing with lifetime guarantee reduces maintenance costs
- Tapered wheel matches track profile, keeping trolley and end trucks centered
- Changeable light press fit wheels can be easily replaced in the field
- Safety—wheels will wear before the track
- 10-year warranty on wheels

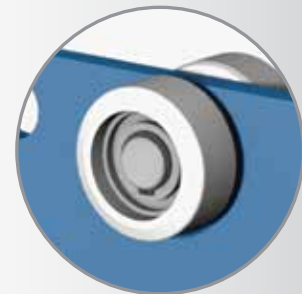

Special Finishes

Whether in a food processing, pharmaceutical, or harsh outdoor environment, all Tether Track Rigid Rail Fall Arrest Systems are available with special finishes to meet the needs of the job.

TETHER TRACK® FAQs

What maximum arresting force (MAF) are your systems designed to?

A Most systems are designed to 900-lb. MAF standard. However, they can be custom designed to 1800-lb. MAF.

Can a Tether Track system support multiple people at one time?

A One of the benefits of a Tether Track Engineered System is that it can be designed to support multiple workers. There is no real limit to the number of people; the system would be designed based on your need/application.

At what intervals does the system have to be supported?

A Each system is designed for the specific application and the number of people on the system. We have customized support centers up to 50'.

Can the systems be used outdoors?

A Yes. However, to prevent oxidation, special finishes are recommended for our Engineered Systems.

Can they be made from stainless steel?

A Yes. Many of the systems can be made from stainless steel. This is recommended if you expect the system to be used in a caustic or wet environment.

How often should the systems be inspected?

A All Tether Track systems should be examined by the user before every use, but must be inspected and documented annually by a "competent person."*

What are the recertification requirements?

A Following a fall, a system must be inspected before being placed back into service. A complete guide on the inspection requirements is included in our installation and maintenance manual.

Can Tether Track be installed inside a building with a sloped roof?

A Yes. Special sloped ceiling hangers are available to address this common application.

Can you curve the track?

A Curves are available. 90-degree curves are the maximum angle we provide as standard.

Is there a rotation brake for a fold away or swing arm system?

A Yes. A swing arm or fold away system can be purchased with a rotation brake — a type of disc brake designed to be reusable in the event of a fall.

Can you motorize the rotation on a swing arm or fold away system?

A Yes. A motorization package can be purchased for both swing arm and fold away systems.

Can these systems be customized outside of what is listed on the literature?

A Yes. Each system is custom designed and engineered for the specific application.

*As defined by OSHA 29 CFR Part 1910

TETHER TRACK® ANCHORAGE ASSESSMENT



Improper fall arrest not only puts your people, your productivity, and your reputation at risk—it can cost your business millions of dollars in fines, lawsuits, insurance premiums, and workers' compensation payments.

One of the most important parts of developing a complete fall protection program is choosing anchorage points from the wide array of options that exist. This assessment is designed as a starting point for you to use when evaluating your current program.

Tether Track engineered anchorage systems are built for maximum safety and productivity.

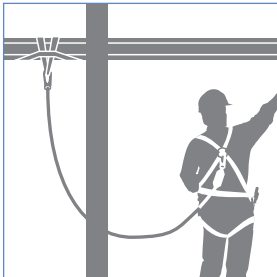
- Take the guesswork out of anchorage selection
- Allow full range of motion
- Meet OSHA requirements
- Wide range of solutions based on the job



ANSWER THESE QUESTIONS TO DETERMINE YOUR FALL ARREST RISK LEVEL		
Do you ever use beams or other parts of a building structure as anchor points?	yes	no
Do workers lack a full range of motion when using your fall protection equipment?	yes	no
Are anchor points ever not directly overhead?	yes	no
Is there doubt about whether all anchor points meet OSHA requirements?	yes	no
Do workers make their own tie-off decisions based on the work being performed?	yes	no
Are anchor points in awkward locations that require workers to perform activities in unnatural positions?	yes	no
Do co-workers get in each other's way when attached to a single anchorage device?	yes	no
Are workers required to disengage from a wire rope horizontal lifeline in order to pass each other?	yes	no
Has a worker ever suffered an injury due to a fall to a lower level?	yes	no
Do workers ever tie off at the waist or feet?	yes	no
<div style="display: flex; justify-content: space-around; align-items: center;"> <div style="text-align: center;">  <p>1 "yes" answer AT RISK</p> </div> <div style="text-align: center;">  <p>2 to 4 "yes" answers INCREASED RISK</p> </div> <div style="text-align: center;">  <p>5+ "yes" answers HIGH RISK</p> </div> </div>		



Make sure you're not exposing your workers or your business to unnecessary risk. Contact us today at **800-821-0086** for a free onsite fall arrest assessment with your local distributor.

Fall Protection Resources

The organizations below can supply complete details regarding fall protection requirements. Much of the information is provided free of charge, while some documents are available only for purchase:

OSHA

Occupational Safety and Health Administration
 osha.gov
 800-321-6742

ANSI

American National Standards Institute
 ansi.org
 212-642-4980

CSA Group

csagroup.org
 800-463-6727

To access Gorbel's FALL PROTECTION TOOLKIT, FALL PROTECTION PLANNING RESOURCE, and FALL ARREST EBOOK, visit www.gorbel.com/righttrack.



FOR MORE INFORMATION

Your authorized Gorbel® dealer can give you more information on what makes Gorbel's Ergonomic Work Station Cranes and other material-handling products "A Class Above."

BRIDGE CRANES



WORK STATION BRIDGE CRANES AND MONORAILS



CLEVELAND TRAMRAIL®



WORK STATION CRANE ERGONOMIC STUDY

ERGONOMIC LIFTING



THE ROI OF ILDS EBOOK



G-FORCE®/EASY ARM®



ERGONOMIC LIFTING STUDY

JIB CRANES



JIB CRANES

GORBEL®
 A C L A S S A B O V E

www.gorbel.com



©2022 Gorbel Inc. All Rights Reserved.

GORBEL

600 Fishers Run
 PO Box 593
 Fishers, NY 14453 USA

Tel.: 800.821.0086

Tel.: 585.924.6262

Fax: 585.924.6273

E: info@gorbel.com